



performance you can depend on

TECHNICAL SPECIFICATIONS

Maytag refrigeration

Models	Maytag TriLogy			Maytag ZigZag	
	SOV026TB	G32026PEKW/S	G32026PELB	SOV626ZB	GZ2626GEKW/B
Model Number	SOV026TB	G32026PEKW/S	G32026PELB	SOV626ZB	GZ2626GEKW/B
Description	Full Stainless Steel	White or Stainless Steel Doors	Black	Full Stainless Steel	White or Black
performance & capacity	Capacity (cu. ft.) Litres Gross/Net	(19.6) 561/552	(19.6) 561/552	(19.6) 561/552	(25.6) 715/696
	Fresh Food Capacity (cu. ft.) Litres Gross/Net	(14.1) 404/399	(14.1) 404/399	(14.1) 404/399	(16.34) 469/460
	Freezer Capacity (cu. ft.) Litres Gross/Net	(5.5) 157/153	(5.5) 157/153	(5.5) 157/153	(9.24) 246/236
	Total Shelf Area (sq. ft.)	22.2	22.2	22.2	23.7
	Energy Class/Climate Class/KWH per year/DBA	A / T / 547/44	A / T / 547/44	A / T / 547/44	A / T / 657/44
	Freezing Capacity	9.5	9.5	9.5	19.4
	Star Rating of Freezer	****	****	****	****
	Four Point Levelling System	•	•	•	•
	Voltage/Hertz	220-240V/50HZ	220-240V/50HZ	220-240V/50HZ	220-240V / 50HZ
	Control System	Electronic	Electronic	Electronic	Electronic
system controls	Water/Ice Filter				•
	Water Filter Indicator – On Controls				•
	Elevator Shelf				•
	Water				•
	Cubed Ice				•
	Crushed Ice				•
	Lock				•
	Dispenser Light (Manual/Auto)				Off / Auto / On
	Water Filter Indicator – Façade				Dual Button Reset
	dimensions	A Cabinet Height: With Hinge (mm)	1796	1775	1775
Cabinet Height: Without Hinge (mm)		N/A	1743	1743	N/A
B Cabinet Width: (mm)		910	905	905	910
C Cabinet Depth: Without Door (mm)		599	597	597	713
Cabinet Depth: With Door (mm)		679	666	677	781
Depth With Door Open to 90 degrees (mm)		1160	1160	1160	1340
Distance from Side Wall to allow 90 degree Door Opening (mm) *		140	140	140	160
Carton H x W x D (mm)		1836 x 997 x 815	1815 x 997 x 815	1815 x 997 x 815	1865 x 997 x 864
Approximate Shipping Weight (kgs)		168	138/150	138	186
extra features		Anti-bacterial Protection	•	•	•
	Auto Defrost	•	•	•	•
	Freezer Shelves	N/A	N/A	N/A	4
	Fridge Position	Top	Top	Top	Right Hand Side
	Fridge Shelves	4	4	4	5
	Frost Free	•	•	•	•
	Freezer Lights	•	•	•	•
	Tilting Door Baskets – Freezer				•
	Ice Maker (Optional Extra)	•	•	•	•
	Fully Extendable Crisper Drawers				•
	Fully Extendable Freezer Baskets				•
	Humidity Controlled Crisper Drawers	•	•	•	•
	Humidity Controlled Meat and Cheese Drawer	•	•	•	•
	Refrigerator Lights	•	•	•	•
	Fitted Panel Kit for 6mm Panels				•
Power Cut Safe Time	7 hours	7 hours	7 hours	7 hours	

* Removing the shelves and drawers requires the doors to be open wider than 90 degrees

panel kit dim's	Height	Width	Max Panel Thickness
	Refrigerator Door (mm)	1695	481
Ice & Water Door Upper (mm)	460	354	6
Ice & Water Door Lower (mm)	815	354	6

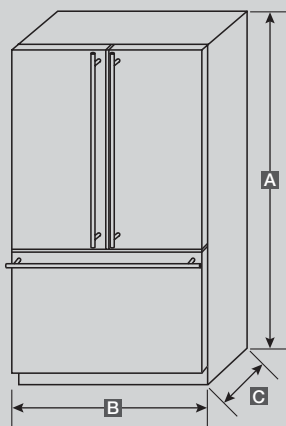

TRIOLOGY

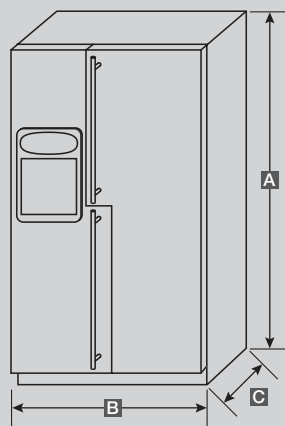

ZIGZAG

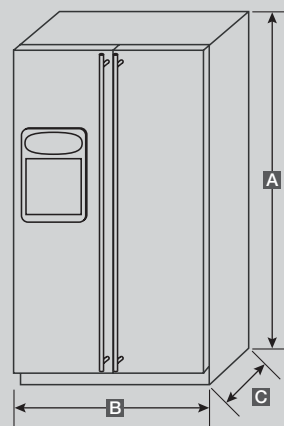

22 SERIES

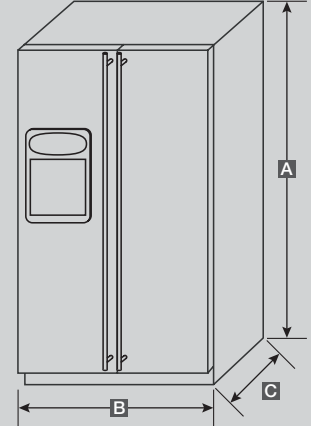

26 SERIES

Maytag 22 Series			Maytag 22 Series without ice & water		Maytag 26 Series	
SOV225GB	GC2225GEKW/B/S	GC2227HEK3/5	SOV225PW	GC2225PEKW/B	SOV626GB	GS2625GEKW/B
Full Stainless Steel	White or Black or S/Steel Doors	White or Black with Panel Kit	Full Stainless Steel	White/Black	Full Stainless Steel	White or Black
(21.57) 610 / 594	(21.57) 610 / 594	(21.57) 610 / 594	(21.5) 625 / 616	(21.5) 625 / 616	(25.6) 712 / 693	(25.6) 712 / 693
(13.48) 395 / 386	(13.48) 395 / 386	(13.48) 395 / 386	(13.51) 395 / 386	(13.51) 395 / 386	(15.83) 454 / 446	(15.83) 454 / 446
(8.09) 215 / 208	(8.09) 215 / 208	(8.09) 215 / 208	(7.96) 230 / 230	(7.96) 230 / 230	(9.77) 258 / 247	(9.77) 258 / 247
18.6	18.6	18.6	21.3	21.3	22.1	22.1
A / T / 593 / 44	A / T / 593 / 44	A / T / 593 / 44	A / T / 584 / 44	A / T / 584 / 44	A / T / 635 / 44	A / T / 635 / 44
12.0	12.0	12.0	13.1	13.1	13.4	13.4
****	****	****	****	****	****	****
.
220-240V / 50HZ	220-240V / 50HZ	220-240V / 50HZ	220-240V/50HZ	220-240V/50HZ	220-240V/50HZ	220-240V/50HZ
Electronic	Electronic	Electronic	Electronic	Electronic	Electronic	Electronic
.
.
.
.
.
.
Off / Auto / On	Off / Auto / On	Off / Auto / On			Off / Auto / On	Off / Auto / On
Dual Button Reset	Dual Button Reset	Dual Button Reset			Dual Button Reset	Dual Button Reset
1815	1778	1778	1815	1778	1815	1778
N/A	1740	1740	N/A	1740	N/A	1740
910	905	905	910	905	912	905
599	597	597	599	597	713	711
666	666	666	666	666	781	781
1160	160	1160	1160	1160	1330	1330
140	160	160	140	140	140	140
1847 x 1005 x 815	1822 x 1003 x 813	1822 x 1003 x 813	1847 x 1005 x 815	1822 x 1003 x 813	1865 x 997 x 864	1816 x 997 x 864
166	136/136/148	136	166	136	186	156
.
.
4	4	4	5	5	4	4
Right Hand Side	Right Hand Side	Right Hand Side	Right Hand Side	Right Hand Side	Right Hand Side	Right Hand Side
5	5	5	4	4	5	5
.
.
.
.
.
.
.
7 hours	7 hours	7 hours	7 hours	7 hours	7 hours	7 hours

We at Maytag are constantly working to make our products better. We therefore reserve the right to change designs or specifications without any notice. E&OE.

To ensure adequate ventilation, please allow 10mm on each side and 25mm on the top and rear of the installation. Heights may vary slightly due to levelling adjustments.

For appliances with ice and water dispensers, allow an extra 25mm at the rear for plumbing connections and a minimum water pressure at the point of connection of between 30 and 120 PSI.

Dimensional specifications are provided for planning purposes only. For complete details see the installation instructions that accompany each product before selecting cabinetry, making cut-outs or beginning installation.

Maytag washing 60 series

	Models	Washing					
		MAF9801AES	MAF9601AES	MAF9601AEW	MAF9501AES	MAF9501AEW	MAH2440AGW
	Model Number	MAF9801AES	MAF9601AES	MAF9601AEW	MAF9501AES	MAF9501AEW	MAH2440AGW
	Colour	Stainless Steel	Stainless Steel	White	Stainless Steel	White	White
performance	Energy Rating *	A	A	A	A	A	A
	Washing Efficiency *	A	A	A	A	A	A
	Spinning Efficiency *	A	A	A	B	B	B
	Water Consumption (Litres) *	54	54	54	54	54	75
	Energy Consumption (kWh) *	1.14	1.14	1.14	1.14	1.14	1.45
	Annual Water Consumption (Litres) †	10800	10800	10800	10800	10800	15000
	Annual Energy Consumption (kWh) †	228	228	228	228	228	290
	Noise Washing d(B)A	47	52	52	54	54	54
	Noise Spinning d(B)A	72	74	74	73	73	73
specification	Load Capacity (kg) *	6kg	6kg	6kg	6kg	6kg	7.5kg
	Spin Speed (rpm) *	1800	1600	1600	1400	1400	1400
	No of Programmes	12	11	11	10	10	11
	Cotons	•	•	•	•	•	•
	Synthetics	•	•	•	•	•	•
	Wool	•	•	•	•	•	•
	Handwash	•	•	•	•	•	•
	Quick Wash	•	•	•	•	•	•
	Variable Temperature	Cold – 95°	Cold – 95°	Cold – 95°	30°, 40°, 50°, 60°	30°, 40°, 50°, 60°	30°, 40°, 50°, 60°, 95°
	Rinse Hold	•	•	•	•	•	•
	Variable Spin	400 – 1800	400 – 1600	400 – 1600	400 – 1600	400 – 1600	•
	Extra Rinse	•	•	•	•	•	•
	Automatic Half Load	•	•	•	•	•	•
	Delay Start	24hr	24hr	24hr	5hr	5hr	19hr
	Memory Programmes	4					
	LCD Display	•					
	LED Display		•	•	•	•	
	Fuzzy Logic	•	•	•	•	•	
	Rotary Control Programme Selector		•	•	•	•	•
	Push Button Programme Selector	•					
	Drop Down Door	•	•	•	•	•	
	Chrome Porthole						•
	4 Point Suspension System	•	•	•	•	•	
	Door Seal on Door	•	•	•	•	•	
	Rubber Bellows Gasket						•
	Porthole Width (mm)	310	310	310	310	310	300
	Cotons Programme Time 60° (mins)	130	135	135	120	120	124
White/ Coloured Cotons 40° (mins)	65	65	65	65	65	101	
Wool/ Handwash (mins)	40	40	40	40	40	40	
Quick Programme Time 40° (mins)	35	35	35	35	35	45	
Nett Weight (kg)	78	78	78	78	78	75	
Gross Weight (kg)	80	80	80	80	80	77	
dim's	A Appliance Height (with maximum foot adjustment) (mm)	850 (+30)	850 (+30)	850 (+30)	850 (+30)	850 (+30)	850 (+20)
	B Appliance Width (mm)	595	595	595	595	595	597
	C Appliance Depth (mm)	595	595	595	595	595	609
	Maximum depth with door/shelf open (mm)	1040	1040	1040	1040	1040	1030

* All measurements are based on 60° cotton cycle
 † All annual values are based on 200 x 60° cotton cycles

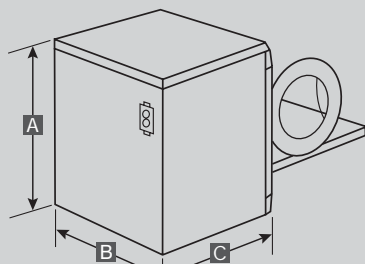

60 SERIES WASHER

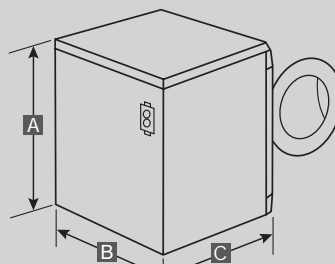

MAH2440AGW

Maytag drying 60 series

	Models	Condensing				
		MDE9901AES	MDE9801AES	MDE9701AEW	MDE9651AES	MDE9651AEW
	Model Number					
	Colour	Stainless Steel	Stainless Steel	White	Stainless Steel	White
performance	Energy Rating	C	C	C	C	C
	Typology	Condenser	Condenser	Condenser	Condenser	Condenser
	Energy Consumption (kWh)	4.38	4.38	4.38	4.38	4.38
	Display	LCD	3 digit LED	3 digit LED	3 digit LED	3 digit LED
	Load Capacity (kg)	6	6	6	6	6
	Time Remaining Display	•	•	•	•	•
progs	No of Programmes	6	6	6	6	6
	Sensor Programmes	4	4	4	4	4
	Timed Dry (mins)	90	90	90	60	60
	Aired Dry (mins)	90	90	90	60	60
options	Number of Temperatures	2	2	2	2	2
	Delay Start	•	•	•	•	•
	Figure of Eight Drying	•	•	•	•	•
dimensions	A Appliance Height (mm)	850	850	850	850	850
	B Appliance Width (mm)	595	595	595	595	595
	C Appliance Depth (mm)	595	595	595	595	595
	Total Depth with Door Open (mm)	1140	1140	1140	1140	1140
	Adjustable Feet	4	4	4	4	4
	Nett Weight (kg)	47	47	47	47	47
	Gross Weight (kg)	49	49	49	49	49
	Noise	69	69	69	69	69

	Models	Vented		Drying Cabinet	
		MDE9601AEW	MDE2440AGW	MDE1100AEW	MDE1100AES
	Model Number				
	Colour	White	White	White	Stainless Steel
performance	Energy Rating	C	C	N/A	N/A
	Typology	Vented	Vented	Vented	Vented
	Energy Consumption (kWh)	4.02	3.93	3.15	3.15
	Display	3 digit LED	3 digit LED	None	None
	Load Capacity (kg)	6	6	3.5	3.5
	Time Remaining Display	•	•	None	None
progs	Sensor Programmes	6	9		
	Timed Dry	60mins	60mins	4 hrs	7 hrs
	Aired Dry	60mins	125mins	4 hrs	4hrs
options	Number of Temperatures	2	3	3	3
	Delay Start	•	•		
	Figure of Eight Drying	•			
dimensions	A Appliance Height (mm)	850	845	1730	1730
	B Appliance Width (mm)	595	597	595	595
	C Appliance Depth (mm)	595	609	609	609
	Total Depth with Door Open (mm)	1140	1069	1204	1204
	Adjustable Feet	4	4	4	4
	Nett Weight (kg)	45	35	60	60
	Gross Weight (kg)	47	37	62	62
	Noise	64	69		

We at Maytag are constantly working to make our products better. We therefore reserve the right to change designs or specifications without any notice. E&OE.

Laundry note

When placing the drying cabinet next to a stacked tumble dryer and washing machine it is necessary to use the pull out shelf accessory in order for the heights and control panels to line up.

The drying cabinet should be vented into an extraction duct if surrounded by cabinetry, or situated in a small room.

Dimensional specifications are provided for planning purposes only. For complete details see the installation instructions that accompany each product before selecting cabinetry, making cut-outs or beginning installation.

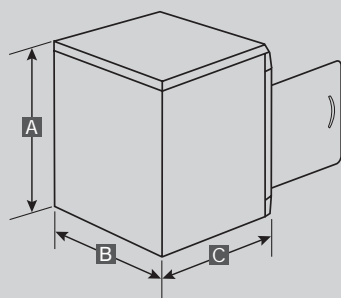

60 SERIES DRYER

Maytag American laundry

	Washing		
	Models	Neptune	Atlanta
	Model Name	MAH7550AGW	MAV5920AGW
performance	Energy Rating *	B	A
	Washing Efficiency *	A	G
	Spinning Efficiency *	B	C
	Water Consumption (Litres) *	88	128.2
	Energy Consumption (kWh) *	1.83	1.81
	Annual Water Consumption (Litres) †	17600	25640
	Annual Energy Consumption (kWh) †	366	362
	Load Capacity (kg) *	8	8
	Spin Speed (rpm) *	1000	1000
	No of Programmes	9	3
specification	Cottons	•	•
	Delicates	•	•
	Reduced Ironing	•	•
	Wool	•	•
	Quick Wash	•	•
	Variable Temperature	•	•
	Prewash	•	•
	Rinse Hold	•	•
	Variable Spin	•	•
	Extra Rinse	•	•
	Stain Brain	•	•
	Memory Programmes	•	•
	LCD Display	•	•
	Fuzzy Logic	•	•
	Touch Screen Controls	•	•
	Rotary Control Programme Selector	•	•
	Colour	White	White
	Cottons Programme Time 60* (mins)	131	
	White / Coloured Cottons 40* (mins)		27
	Wool / Handwash (mins)		15
Quick Programme Time 40* (mins)	57	9	
Nett Weight (kg)	91	91	
Gross Weight (kg)	96	96	
dim's	A Appliance Height (with maximum foot adjustment) (mm)	1080	1350
	B Appliance Width (mm)	690	690
	C Appliance Depth (mm)	700	700

* All measurements are based on 60° cotton cycle
 † All annual values are based on 200 x 60° cotton cycles

	Drying		
	Models	Neptune	Atlanta
	Model Name	MDE7550AGW	MDE3706AGW
performance	Energy Rating	C	C
	Typology	See note opposite	See note opposite
	Display	LCD	
	Load Capacity (kg)	8	8
	Time Remaining Display	•	
progs	No of Programmes	6	3
	Sensor Programmes	4	2
	Timed Dry (mins)	45	100
	Aired Dry	20	
dimensions	Number of Temperatures	4	4
	A Total Height (mm)	700	700
	B Total Width (mm)	1080	1080
	C Total Depth (mm)	690	690
	Adjustable Feet	4	4
	Nett Weight (kg)	73	73
	Colour	White	White

		Washer Dryer
Model		Osiris
Model Name		LSE7806AGE
Model Number		
performance	Energy Efficiency	F
	Washing Efficiency	G
	Spin Efficiency	C
	Load Capacity (kg)	7.25
programmes	No of Wash Programmes	3
	Wool	•
	Regular	•
	Delicates	•
	Wash Temperatures	3
	Load Setting	Small / Med / Large
	No of Drying Programmes	4
	No of Sensor Programmes	2
	Timed Dry (mins)	60
	Air Fluff (mins)	20
dimensions	Washer Height (mm)	870
	Washer Width (mm)	700
	Washer Depth (mm)	700
	Dryer Height (mm)	870
	Dryer Width (mm)	700
	Dryer Depth (mm)	540
	A Total Height (mm)	1860
	B Total Width (mm)	700
	C Total Depth (mm)	700
	Nett Weight (kg)	158
Gross Weight (kg)	163	

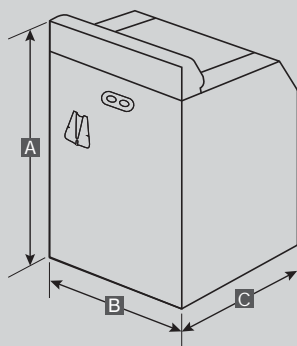

ATLANTA WASHER

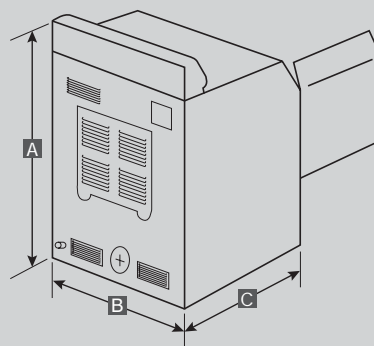

ATLANTA DRYER

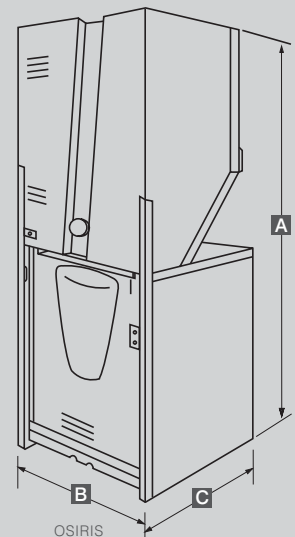

OSIRIS

Maytag dishwashing

	Model	Dishwashing		
		MSE661AES/W	MSE760AES	MSE860AES
	Model Number			
	Colour	Stainless Steel / White	Stainless Steel	Stainless Steel
performance	Energy Efficiency	A	A	A
	Washing Efficiency	A	A	A
	Drying Efficiency	A	A	A
	Energy Consumption (kWh) *	1	1	1
	Water Consumption (Litres)	11	9.9	9.9
	No of Place Settings (IEC)	12	12	12
	Display	LEDs	none	LCD
	Time Remaining Display	N	N	•
	No of Spray Areas	7	8	8
programmes	No of Programmes	4	6	10
	Heavy Soil	•	•	•
	Normal	•	•	•
	Quick	•	•	•
	Delicate Wash		•	•
	Autowash		•	•
	Mixed Wash			•
	Half Load Upper Basket			•
	Half load Lower Basket			•
	Rinse and Hold	•	•	•
Rinse and Dry			•	
options	No of Wash Temperatures	6	8	9
	No of Drying Options	3	3	3
	Delay Start		5 hour	24 hour
	Express		•	•
	Super Rinse			•
	Half Load		•	
upper basket	Divisible Cup Shelf	•	•	•
	Foldable Glass Support			•
	Fixed Glass Support	•	•	
	Wine Glass Shelf	•	•	•
	Adjustable Plate Rack			•
	Fixed Plate Supports	•	•	
	Dedicated Knife Basket		•	•
lower bsckt	Knife Stand	•	•	•
	Foldable Plate Rack		•	•
	Fixed Plate Rack	•		
	Cutlery Basket	•	•	•
dim's	Wine Glass Shelf			•
	A Dishwasher Height (mm)	850	850	850
	B Dishwasher Width (mm)	600	600	600
features	C Dishwasher Depth (mm)	590	590	590
	Adjustable Feet	4	4	4
	Nett Weight (kg)	57	61	67
	Gross Weight (kg)	59	63	69
	Noise dB(A)	50	48	46

* Inlet water at 15° C

We at Maytag are constantly working to make our products better. We therefore reserve the right to change designs or specifications without any notice. E&OE.

American laundry note

American washing machines require equal water pressures in both the hot and cold water inlet hoses. The water pressure must be between 30 and 120 PSI.

American dryers and the Osiris require a 30 amp electrical connection. These machines must be installed by a qualified electrician.

Neptune and Atlanta dryers require venting into a rigid metal duct. American dryers come with venting to the rear as standard. However, if stated at point of order, we can arrange for venting to the left, right or even from below.

Dishwasher note

Please allow an extra 25mm at the rear of the appliance to allow for plumbing connections.

Dimensional specifications are provided for planning purposes only. For complete details see the installation instructions that accompany each product before selecting cabinetry, making cut-outs or beginning installation.

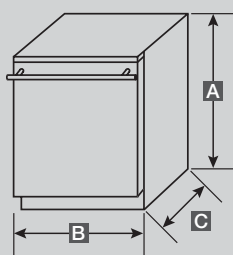

VARA DISHWASHER

Maytag cooking & floorcare

Models		Range cooking	
Model Number	SOV110RC	SOV110RB	
Colour	Stainless Steel	Black	
HOB			
3.5kW Ring Wok Burners	2	2	
3.0kW Burner	1	1	
1.7kW Burner	2	2	
1.0kW Burner	1	1	
Cast Iron Pan supports	Matt	Gloss	
Cast Iron Wok ring	•	•	
Sit on Griddle Plate	•	•	
WARMING CAVITY			
Temperature Controlled	•	•	
GRILL CAVITY			
Electric Dual Circuit	•	•	
Grill Pan & Trivet	•	•	
Depth (mm)	490	490	
MULTI FUNCTION OVEN CAVITY			
Size, litres	62	62	
Energy Rating	B	B	
No of Functions	7	7	
Defrost	•	•	
Fan Oven	•	•	
Fan Assisted	•	•	
Fanned Grilling	•	•	
Conventional Oven	•	•	
Browning Element	•	•	
Base Heat Only	•	•	
No of Shelves	2	2	
Shelf Positions	6	6	
CONVENTIONAL OVEN CAVITY			
Size, litres	67	67	
Energy Rating	A	A	
No of Shelves	2	2	
Shelf Positions	4	4	
Roasting Tin	•	•	
dim's			
A Height (mm)	900	900	
B Width (mm)	1096	1096	
C Depth (mm)	595	595	

Models		Hoods	
Model Numbers	SOV120HD	SOV120HDB	
Colour	Stainless Steel	Black	
Speed	3	3	
Noise dB(A)	50 - 68	50 - 68	
No of Filters	4	4	
Lights	2	2	
EXTRACTION METHOD			
Recirculation	•	•	
External Venting	•	•	
dimensions			
A Height (mm)	1200	1200	
Width (mm)	1198	1198	
C Depth (mm)	490	490	
B Chimney Width (mm)	275	275	
Chimney Depth (mm)	150	150	

Installation guidelines

A space of at least 650mm must be left between the top of the pan support to the underneath of the hood. The range cooker must be installed at least 130mm from a side wall, in order to allow the oven doors to be opened.

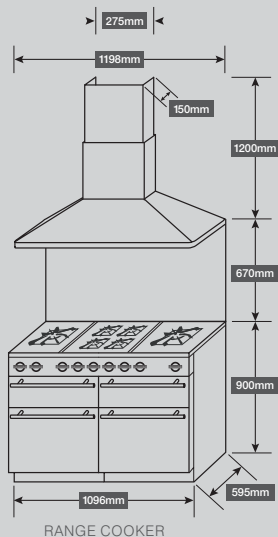

Model		Satellite floor cleaner
Model Number	S3340001	
Bag Size	4 Litres	
Filtration	HEPA	
Weight (kg)	6	
Dimensions - Body only (mm)	H 370 x W 370 x D 370	
Hose Type	Clear Stretch - 3.6 Metre Stretch - Crush Proof	
Wands	Telescopic Stainless Steel Tube	
Hose Swivel	360°	
Maximum Tool Reach	5m (17ft) (using Hose, Telescoping Wand, Turbine Nozzle)	
Power Cord Length	8m (24ft)	
Motor Rating	2000 watts	
Max Airpower	293 air watts	
Max Noise Level	74dBA	
HEPA Replacement Bag pack (2 bags & 1 filter)	Part No. 623911001s	

Model		Agility deep carpet & upholstery cleaner
Model Number	F6212901	
Weight (kg)	10.24	
Dimensions (Total Extended) (mm)	H 1095 x W 300 x D 460	
Solution Tank Capacity	4 Litres	
Cord Length	8.0 metres	
Hose Stretch	2.6 metres	
Coverage	9.29 square metres	
Motor Rating	1200 Watts	
Advanced Formula Solution - 1 Litre	Part No. FCAGADV1L	

Model		Floor2Floor - hard floor cleaner
Model Number	H3030001	
Weight	7.6kg	
Dimensions (Total Extended) (mm)	H 1100 x W 350 x D 350	
Solution Tank Capacity	900ml Measuring Cap = 30/60ml	
Cord Length	8.0 metres	
Noise Level	81 dBA nominal	
Coverage (based on single pass, 0.2 m/s)	17.2 square metres	
Motor Rating	700 Watts	
Hard Floor Cleaning Solution - 500ml	FCF2FHFC05	
Grout Cleaning Solution - 500ml	FCF2FGCS05	
Filter	59178287	

We at Maytag are constantly working to make our products better. We therefore reserve the right to change designs or specifications without any notice. E&OE.

